



COREMO OCMEA S.P.A.

Via Galilei, 12 - 20090 Assago (MI) - Italy

Tel. +39 024880697 Fax +39 024881940

www.coremo.it info@coremo.it

User and Maintenance Manual

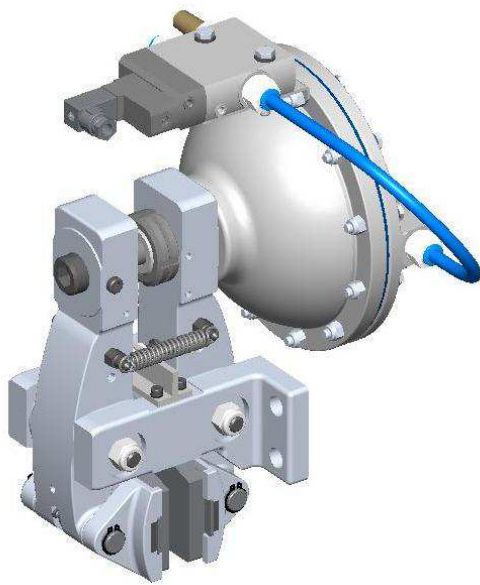

F Pneumatic positive

Model F3 SPECIAL KHS

cod. A4150/A4151



ISO 9001 - Certificate N°0238

Translation of the original instructions
EN 151117 REV. 0



	User and Maintenance Manual <i>“F” Caliper brake</i>		Model F3 SPECIAL KHS cod. A4150/A4151
	Date: 2015/11/17	Revision: 0	www.coremo.it

TABLE OF CONTENTS

1.	Introduction.....	3
2.	Manufacturer.....	3
3.	General information	3
4.	Warnings.....	4
5.	Technical data.....	5
5.1.	Product performance	5
5.2.	Brake lining wear	6
5.3.	Special note	6
6.	Transport and storage	6
7.	Installation.....	7
8.	Operation.....	9
8.1.	Power supply of the product	9
8.2.	Improper use	9
9.	Maintenance and cleaning	10
9.1.	Readjusting the play	10
9.2.	Changing the lining pads and cleaning the friction surfaces.....	10
9.3.	Changing the thruster spring.....	10
9.4.	Changing the diaphragm and the gaskets	11
9.5.	Changing the brake shoe alignment springs	11
9.6.	Periodic maintenance.....	12
10.	Spare parts list	12
11.	Data sheets	13
11.1.	Limit switch cod. H0018	13
11.2.	Solenoid valve cod. H0107.....	14
11.3.	Plug socket cod. H0108.....	15
11.4.	Silencer cod. H0109	16
12.	Drawing.....	17

	User and Maintenance Manual <i>"F" Caliper brake</i>		Model F3 SPECIAL KHS cod. A4150/A4151
	Date: 2015/11/17	Revision: 0	www.coremo.it

1. Introduction

The purpose of this manual is to provide the user with all the information necessary to use the product properly, independently and safely.

This manual constitutes an integral part of the safety features and must be read in its entirety before installation and use of the product. It must therefore be kept in a safe place should future reference be necessary before proceeding with any kind of work.

The user is strongly advised to read it carefully and to follow the rules and procedures contained in it as these provide important information concerning safe use and maintenance.

If any doubt should arise concerning the correct interpretation of the instructions, contact our technical department for the necessary clarification.

It is prohibited for anyone to disclose or modify the content of this manual or to use it for personal purposes.

2. Manufacturer

COREMO OCMEA S.P.A.

Via Galilei, 12 - 20090 Assago (MI) - Italy

Tel.: +39 024880697 Fax: +39 024881940

e-mail: info@coremo.it

3. General information

Correct use of the product: In compliance with Italian Legislative Decree 17/2010 and DIRECTIVE 2006/42/EC the operating limits for ideal and safe use of the product are stated in this manual.

Design parameters: COREMO OCMEA caliper brakes have been designed for use in conformity with the performance and conditions stated in the catalogue and Chapter 5.1 of this manual. It is advisable not to exceed these limitations.

Model selection: Selection of the correct model for a given application is of basic importance. The technical department of COREMO OCMEA can provide you with information, suggestions and assistance regarding correct application and use.

	User and Maintenance Manual <i>“F” Caliper brake</i>		Model F3 SPECIAL KHS cod. A4150/A4151
	Date: 2015/11/17	Revision: 0	www.coremo.it

Use: Compliance with the assembly and maintenance instructions prevents not only costly down time but also accidents due to incomplete knowledge of the product.

Rotating parts: The caliper brakes are coupled mainly with rotating parts. In this case the moving parts must be protected in conformity with the requirements of DIRECTIVE 2006/42/EC and Italian Legislative Decree 17/2010 or equivalent legislation in force in the countries in which they are used.

Power source for pneumatic brakes: Use air not contaminated with oil or water and a 25 micron filter with automatic condensation discharge.

Friction material: All COREMO OCMEA caliper brakes are fitted with friction material which is absolutely free of asbestos and is declared as NON toxic/harmful in full observance of health and environment regulations and laws. In any case it is better not to inhale dust produced by them and to wash hands thoroughly before eating or drinking.

Oils, greases, lubricating components: These are used in extremely limited quantities. Personnel suffering from allergies to these substances are advised to wear gloves or use protective cream which must be washed off thoroughly before eating or drinking.

Product markings: All the data on the plates must always be kept legible. Use the data shown on the plates when contacting the manufacturer for spare parts, information or assistance for example.

Disposal: Worn brake lining pads and other materials of which brakes are made are classified as special NON toxic/harmful products and therefore must be disposed of in accordance with the laws in force in the countries in which they are used.

4. Warnings

	<p>Failure to follow the instructions in this manual and on any plates attached to the product exposes persons to risks and may cause damage to other equipment and machinery.</p>
-------------------------------------------------------------------------------------	-------------------------------------------------------------------------------------------------------------------------------------------------------------------------------------------

- The product must not be used at an ambient temperature lower than -20 °C.
- The disc must be made of iron alloy (cast iron or steel) having a hardness in the range 190 to 220 HB.

The technical department of COREMO OCMEA can provide additional information in order to ensure correct application and use of the product.

Dangers caused by a power failure: A power failure will cause the brakes to fail. It is therefore necessary to provide an uninterrupted power supply or, if the case requires, use suitable power failure warning systems as a brake failure may cause personal injury and damage to property.

	User and Maintenance Manual <i>“F” Caliper brake</i>		Model F3 SPECIAL KHS cod. A4150/A4151
	Date: 2015/11/17	Revision: 0	www.coremo.it

Danger of breakage during operation: To reduce the risk of breakage during operation carry out the periodic inspections shown in this manual.

Risks connected with changes in operating conditions: The product is designed for the purposes stated in this user and maintenance manual therefore the power supply pressure required for the brake to work safely and reliably is indicated. The operating conditions also vary depending on the diameter of the brake disc used; this manual contains an equation to calculate the dynamic torque provided as a function of the disc diameter. Please note that an erroneous calculation may result in a braking torque different to the desired value which could compromise aspects of safety.

Residual risk: Residual risk can be attributed to the operator not following all the procedures stated in the user and maintenance manual and not giving due consideration to the warnings.

5. Technical data

5.1. Product performance

Brake type F3 SPECIAL KHS is equipped with a 3/2 NC valve, code H0107. The use of the brake for emergency or maneuvering is expected, provided that the H0107 valve switches when the braking is required.



Use of the product for any purpose other than those indicated may represent a risk to any aspect of safety.

The F3 SPECIAL KHS brake applies a tangential force of 12700 N when powered at a pressure of 6 bar and attributing a coefficient of friction of 0.4

Warning: The value of the friction coefficient is purely theoretical as it depends on environmental conditions and on how the product is used.

The dynamic torque provided by the brake will be a function of the diameter of the disc used for each single type of product and can be determined using the following equation:

$$\text{Dynamic torque [Nm]} = \text{Tangential force [N]} \times (\text{radius of the disc [m]} - 0.033)$$



An error in calculation will result in a braking torque different to the desired value and a risk to aspects of safety.
The technical department of COREMO OCMEA can provide information, suggestions and assistance for correct application and use of the product.

	User and Maintenance Manual "F" Caliper brake		Model F3 SPECIAL KHS cod. A4150/A4151
	Date: 2015/11/17	Revision: 0	www.coremo.it

5.2. Brake lining wear



The thickness of each single new lining is 11 mm. A maximum overall lining wear of 12 mm is allowed. Failure to remain within the above limit may represent a risk to aspects of safety.

5.3. Special note

During braking kinetic energy is converted into heat caused by friction between the surfaces of the brake linings and the brake disc. It is therefore fundamentally important to consider the amount of heat that can be dissipated.



Ignoring the heat produced during braking affects brake lining wear and may jeopardize the safety of the operators and the reliability of the product. Since a brake can be used for many applications, it is advisable to contact the technical department of COREMO OCMEA for further explanation in this regard.

6. Transport and storage



Personnel assigned to this work must wear suitable PPE such as gloves, safety footwear and take any other precautions necessary before proceeding with transport, handling and storage of the this part.

1. **Transport:** When handling it is important to bear in mind the dimensions and weight of each single type of product as shown in the product drawing enclosed with this manual and in the catalogue of the brake type in question.
2. **Storage:** When storing brakes it is important to bear in mind that a considerable weight is concentrated in a small space. Personnel assigned to this work must wear suitable PPE (safety footwear, gloves, and take any other appropriate precautions) in order to avoid the risk of injury.

	User and Maintenance Manual "F" Caliper brake		Model F3 SPECIAL KHS cod. A4150/A4151
	Date: 2015/11/17	Revision: 0	www.coremo.it

7. Installation



THE BRAKE MUST BE INSTALLED WITH THE MACHINE OFF.

Personnel assigned to this work must wear suitable PPE such as gloves, safety footwear and take any other appropriate precautions to ensure adequate protection and avoid the risk of injury.

Before installation, remove the spacer between the pads. To remove this spacer, widen the space between the pads, rotating the grub screw C62097 (Figure 1) using a n. 12 Allen key, after loosening the grub screws (C61728) using a 5 Allen key. Once the spacer has been removed, proceed with the installation.

1. Mount the brake on a rigid flat surface of the machine or on a support capable of withstanding a tangential force greater than 18700 N.

The brake can be mounted in any position as it is provided with a balancing system for the levers and alignment of the brake shoes. Anchor the brake to the supporting base using 4 class 8.8 M12 screws and a tightening torque of 85 Nm.

2. Adjust the play between the brake linings and the disc using the play adjuster and a n. 12 Allen key, rotating in the appropriate direction (Figure 1) after loosening the grub screws (C61728) using a 5 Allen key; when a play of 1 mm between the disc and each brake lining has been obtained, block the adjuster C62097 in position locking the grub screws (C61728) using a n. 5 Allen key.

Adjust the screw C61220 located between the levers using a n. 10 spanner, until the weight of the thruster is balanced; when balanced lock the screw by tightening the nuts.

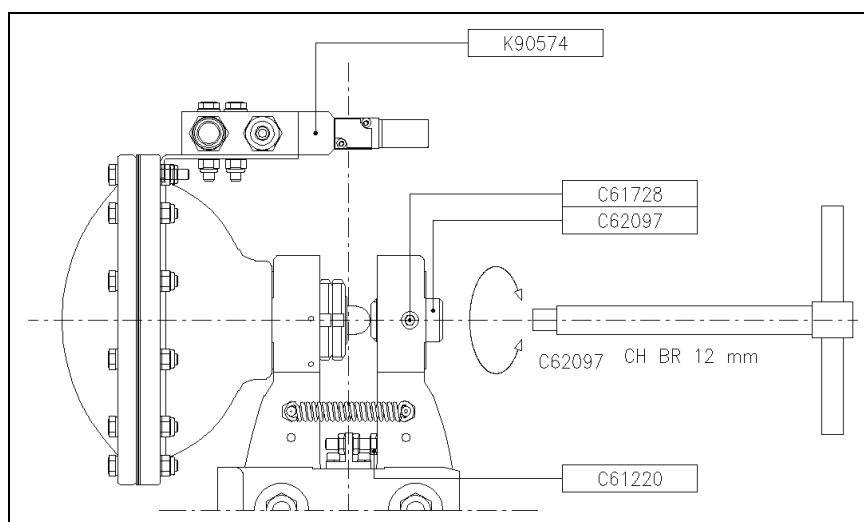

Figure 1

- Adjust the brake shoes using the grub screw C61724 rotating it in the appropriate direction with a n. 3 Allen key; the friction surface of the brake linings must be parallel to the surface of the disc (Figure 2).

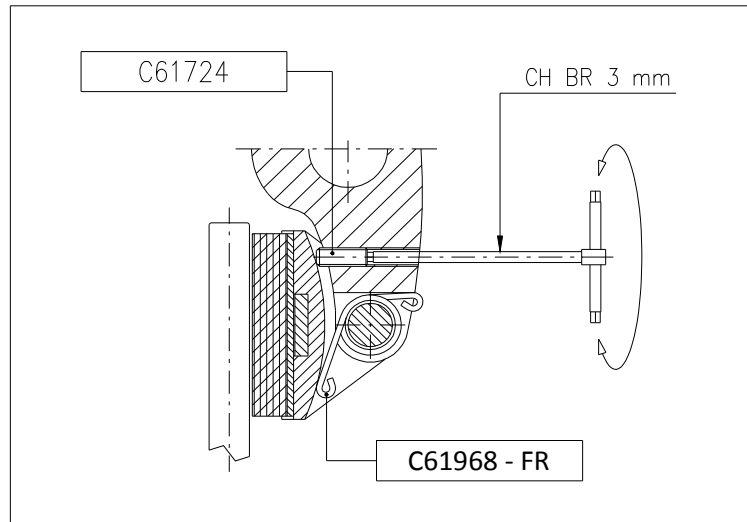

Figure 2

- Connect the solenoid valve assembly K90574, placed on the thruster of the brake (Figure 1), to the supply line using the 3/8" gas fitting H0110 as per position 1 (Figure 3) and a flexible hose long enough to allow wide possibilities of movement to the thruster.

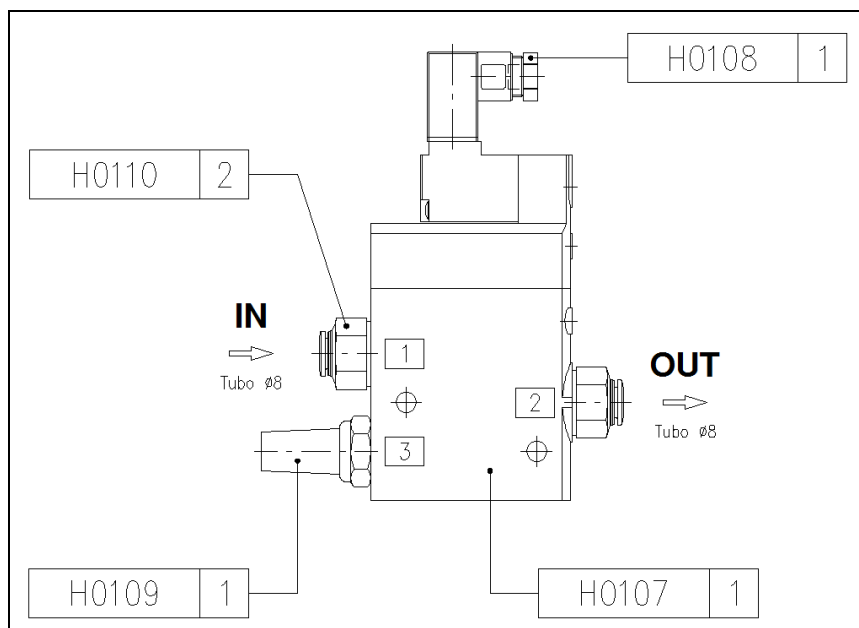



Figure 3

	User and Maintenance Manual "F" Caliper brake		Model F3 SPECIAL KHS cod. A4150/A4151
	Date: 2015/11/17	Revision: 0	www.coremo.it

5. The control pressure must not exceed 8 bar. The air must not be contaminated with oil or water, therefore a 25 micron filter with automatic condensate discharge should be used.



Do not apply the brake without the disc positioned between the brake linings; failure to follow this rule could result in fingers being crushed and other dangers in addition to damage to the brake itself.

6. **BEDDING-IN:** The initial braking torque may be from 30% to 50% less than the rated value until the brake lining adjusts to the disc.

8. Operation

8.1. Power supply of the product

Chapter 5.1 contains a table of the tangential force provided by product and the relevant equation for calculating the braking torque as a function of the diameter of the disc used.

The control pressure must not exceed 8 bar.

The technical department of COREMO OCMEA can provide information, suggestions and assistance for correct application and use of the brake.



The wrong power supply pressure will result in a tangential force different to the value indicated in this manual; the braking torque of the product will therefore be different to the value desired and represent a risk to safety aspects.

8.2. Improper use

The products considered here must be used exclusively as described in Chapter 5 of this manual. Any other use is to be considered improper. The manufacturer declines all responsibility for damage caused by erroneous or unreasonable use of the product.



Use of the product for purposes other than those stated in this manual may compromise any aspect of safety.

	User and Maintenance Manual “F” Caliper brake		Model F3 SPECIAL KHS cod. A4150/A4151
	Date: 2015/11/17	Revision: 0	www.coremo.it

9. Maintenance and cleaning



ALL TYPES OF WORK ON THE BRAKE MUST BE DONE WITH THE MACHINE OFF.

Staff assigned to this work must wear suitable PPE such as gloves and safety footwear and take any further precautions necessary to ensure adequate protection and prevent injury. Failure to follow the instructions given for maintenance and cleaning of the product may compromise personal safety and cause damage to equipment and machinery.



High temperatures may be produced after braking on the surfaces of the disc brake and the brake linings. Personnel must therefore wait for parts subject to overheating to cool down and wear suitable protective gloves and PPE.

9.1. Readjusting the play

1. Cut off pressure to the thruster, loosen the grub screws C61728 (Figure 1).
2. Rotate the play adjuster clockwise until the optimal play of 1 mm is obtained between the disc and each brake lining (see Chapter 7 point 2).
3. Lock the grub screws C61728 (Figure 1).
4. Realign the brake shoes as described in point 3 of Chapter 7.

9.2. Changing the lining pads and cleaning the friction surfaces

1. Cut off pressure to the thruster.
2. Remove the seeger rings C61275, then pull out the pin C61872 and remove the shoe Z50263-FR.
3. Remove the worn linings levering the metal part to overcome the force of the magnet which holds it in its seat. Check that the magnet is well housed in the shoe.
4. Remove any oil or grease from the surface of the disc using a non-pollutant detergent.
5. If the lining pads are contaminated only superficially it is better to clean them using fine emery cloth. If the contamination of the linings is deep or at the maximum wear limit as indicated in Chapter 5.2 and stated in the catalogue, replace them with new linings.
6. Reassemble the shoe following the sequence in point 2 in reverse order, positioning the shoe alignment spring C61968-FR as indicated in Figure 2.
7. Readjust the play between the disc and lining as described in Chapter 9.1.

9.3. Changing the thruster spring

1. Cut off pressure to the thruster and disconnect the power line. Unscrew the ring nuts and remove the thruster from the brake.

	User and Maintenance Manual <i>“F” Caliper brake</i>		Model F3 SPECIAL KHS cod. A4150/A4151
	Date: 2015/11/17	Revision: 0	www.coremo.it

2. Remove the tube that connects the thruster to the solenoid valve K90574.
3. Remove the screws that anchor the thruster body to the cover paying attention not to damage the valve.
4. Remove the cover and the diaphragm.
5. Pull out the internal thruster unit / plate and replace the spring. Grease the stem before putting the internal thruster back.
6. Put back the cover following the procedure in points 4 and 3 in reverse order positioning the solenoid valve K90574 correctly.
7. Reconnect the thruster to the solenoid valve K90574 in position 2 of the H0107 valve (Figure 3).
8. Put the thruster back on the brake anchoring it with the two ring nuts. Reconnect the flexible hose.
9. Apply the brake a number of times to ensure that the internal thruster slides perfectly and check for any air leaks.

9.4. Changing the diaphragm and the gaskets

1. Cut off pressure to the thruster and disconnect the power line. Unscrew the ring nuts and remove the thruster from the brake.
2. Remove the tube that connects the thruster to the solenoid valve K90574.
3. Remove the screws that anchor the thruster body to the cover paying attention not to damage the valve.
4. Remove the cover and replace the diaphragm.
5. Put back the cover positioning the solenoid valve K90574 correctly.
6. Reconnect the thruster to the solenoid valve K90574 in position 2 of the H0107 valve (Figure 3).
7. Put the thruster back on the brake anchoring it with the two ring nuts. Reconnect the flexible hose.
8. Apply the brake a number of times to ensure that the internal thruster slides perfectly and check for any air leaks.

9.5. Changing the brake shoe alignment springs

1. Cut off pressure to the thruster.
2. Remove the seeger rings C61275, then pull out the pin C61872 and remove the shoe Z50263-FR.
3. Remove the shoe alignment spring C61968-FR from its seat and replace it with a new one, positioning it as shown in Figure 2.
4. Remount the brake shoe following the procedure in point 2 in reverse.
5. Readjust the play between the disc and the lining as described in Chapter 9.1.

	User and Maintenance Manual “F” Caliper brake		Model F3 SPECIAL KHS cod. A4150/A4151
	Date: 2015/11/17	Revision: 0	www.coremo.it

9.6. Periodic maintenance



All inspections must be done with the machine switched off..

Although the intervals between these inspections depend on the frequency of use of the brake, they should be done every 3 months in any case so as not to compromise all aspects of safety.

1. Check that the play between each lining pad and the friction disc does not exceed 1 mm. If the play is too large adjust it to the initial value as described in Chapter 9.1. When the wear of each lining reaches 6 mm replace it as described in Chapter 9.2.
2. Check that the surfaces of the linings and the disc are not contaminated with grease, oil or similar substances as these prevent the brake from working effectively.
3. Check that the anchoring screws of the brake and the brake units are correctly tightened.
4. Check the condition of the flexible hoses.
5. Apply the brake a number of times to check the condition of the gaskets, the operation of the springs and correct sliding of the stem.

10. Spare parts list

To avoid costly down time we recommend keeping a stock of spare parts adequate for the number of brakes as listed below:

Lining pads:	Cod. N° Z50055	ST 11	
	Cod. N° Z50118	ST 11	with wear indicator
Thruster spring:	Cod. N° C60920		
Shoe alignment springs:	Cod. N° C61968-FR		
Lever balance springs:	Cod. N° C61951-FR		with disc of thickness 14 mm
Diaphragms:	Cod. N° C60920		
ON/OFF indicator:	Cod. N° K90313	Limit switch	cod. H0018
Solenoid Valve Assembly:	Cod. N° K90574	Solenoid valve	cod. H0107
		Plug socket	cod. H0108
		Silencer	cod. H0109

These spare parts must be kept in a place that is preferably dark, cool and far from substances that could reduce their functionality.

11. Data sheets

11.1. Limit switch cod. H0018

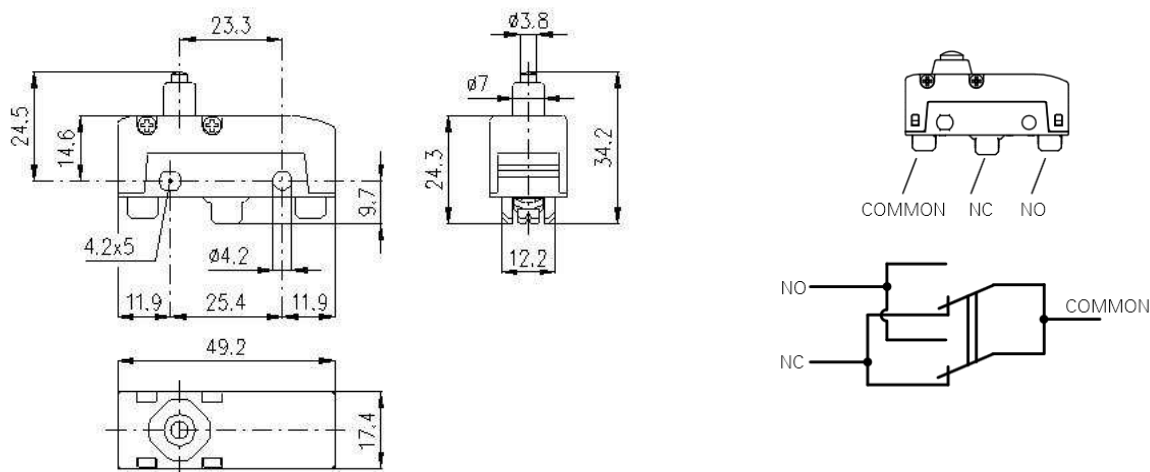

Technical data

Made of glass-reinforced polymer, self-extinguishing, shock-proof thermoplastic resin

Protection degree:

IP65 according to EN 60529

Ambient temperature:

from -25°C to +85°C

Max actuation frequency:

3600 operations cycles^(*)/hour

Mechanical endurance:

10 million operations cycles^(*)

^(*) One operation cycle means two movements, one to close and one to open contacts, as foreseen by EN 60947-5-1 standard

In conformity with standards:

IEC 60947-5-1, EN 60947-5-1, IEC 60529, EN 60529

In conformity with requirements requested by:

2006/95/CE, 2006/42/CE, 2004/108/CE

Positive contact opening in conformity with standards: IEC 60947-5-1, EN 60947-5-1, VDE 0660-206

Electrical data

Thermal current (I_{th}):

16 A

Rated insulation voltage (U_i):

250 Vac 300 Vdc

Rated impulse withstand voltage (U_{imp}):

4 kV

Conditional short circuit current:

1000 A according to EN 60947-5-1

Protection against short circuits:

fuse 16 A 250 V tipo gG

Pollution degree:

3

Dielectric strength:

2000Vac/min

Utilization categories

Alternate current: AC15 (50÷60 Hz)

Cable section (corde di rame flessibile)

U_e (V) 250 120

min. 1 x 0,34 mm²

I_e (A) 6 6

Max. 2 x 1,5 mm²

Direct current: DC13

U_e (V) 24 125 250

I_e (A) 5 0,6 0,3

11.2. Solenoid valve cod. H0107

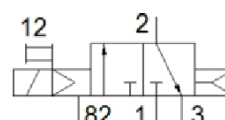
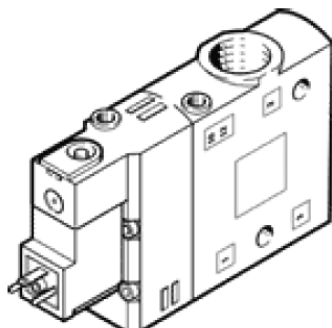

Feature	values
Valve function	3/2 closed, monostable
Type of actuation	electrical
Width	24 mm
Standard nominal flow rate	2,500 l/min
Operating pressure	2.5 ... 10 bar
Design structure	Piston slide
Type of reset	Air spring
Protection class	IP65 with plug socket to IEC 60529
Authorisation	c UL us - Recognized (OL) Germanischer Lloyd
Nominal size	11 mm
Sealing principle	soft
Assembly position	Any
Manual override	with accessories, detenting Pushing
Type of piloting	Piloted
Pilot air supply	Internal
Flow direction	non reversible
Valve position identification	Inscription label holder
Freedom from overlap	Yes
Note on forced dynamisation	Switching frequency at least once a week
Switching time off	33 ms
Switching time on	50 ms
Duty cycle	100%
Max. positive test pulse with logic 0	3,300 µs
Max. negative test pulse with logic 1	3,100 µs
Characteristic coil data	24 V DC: 1.5 W
Permissible voltage fluctuation	-15 % / +10 %
Operating medium	Compressed air in accordance with ISO8573-1:2010 [7:4:4]
Note on operating and pilot medium	Lubricated operation possible (subsequently required for further operation)
Vibration resistance	Transport application test at severity level 2 in accordance with FN 942017-4 and EN 60068-2-6
Shock resistance	Shock test SG2 to FN/EN
Corrosion resistance classification CRC	2
Medium temperature	-5 ... 50 °C
Ambient temperature	-5 ... 50 °C
Product weight	220 g
Electrical connection	Design C
Mounting type	with through hole
Pilot exhaust port 82	M5
Pilot air port 12	M5



User and Maintenance Manual

"F" Caliper brake

Model F3 SPECIAL KHS
cod. A4150/A4151

Date: 2015/11/17

Revision: 0

www.coremo.it

Feature	values
Pneumatic connection, port 1	G3/8
Pneumatic connection, port 2	G3/8
Pneumatic connection, port 3	G3/8
Materials note	Conforms to RoHS
Materials information for seals	NBR
Materials information, housing	Aluminium die cast

11.3. Plug socket cod. H0108

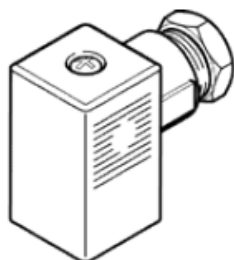

Feature	values
Permissible cable diameter	7.5 mm
Assembly position	Any
Nominal operating voltage, AC	250 V
Nominal operating voltage DC	300 V
Surge strength	4 kV
Permissible current load	6 A
Degree of contamination	3
CE mark (see declaration of conformity)	to EU directive low-voltage devices
Protection class	IP65 to IEC 60529
Ambient temperature	-45 ... 90 °C
Max.tightening torque plug	0.25 Nm
Product weight	11 g
Terminal cross-section	0.75 mm ²
Electrical connection	Plug socket angled Per DIN EN 175301-803 Rectangular design, MSN2 Design C Rectangular design, MSEB Plug socket 3-pin According to DIN EN 61984
Cable diameter	6 ... 8 mm
Cable gland connection	Pg7
Nominal conductor cross-section	≤ 0.75 mm ²
Mounting type	On solenoid valve with M2.5 central screw
Housing colour	Black
Materials information for seals	NBR
Materials information, housing	Plastic

	User and Maintenance Manual "F" Caliper brake		Model F3 SPECIAL KHS cod. A4150/A4151
	Date: 2015/11/17	Revision: 0	www.coremo.it

11.4. Silencer cod. H0109

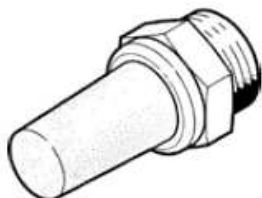

Feature	values
Assembly position	Any
Container size	10
Operating pressure	0 ... 10 bar
Flow rate to atmosphere	5,430 l/min
Operating medium	Compressed air in accordance with ISO8573-1:2010 [7:...]]
Note on operating and pilot medium	Lubricated operation possible
Corrosion resistance classification CRC	1
Sound pressure level	82 dB(A)
Ambient temperature	-10 ... 80 °C
Product weight	26 g
Pneumatic connection	G3/8
Materials information for silencer insert	Bronze
Materials information for screw-in stud	Brass
Materials note	Conforms to RoHS

